



衍惠电子

AC SOCKET



DB-14-T-8-P13 2.5A/250Vac & 5A/250Vac

SPECIFICATION



1. Dielectric withstand strength	AC 2000V/1min
2. Insulation resistance	$\geq 100M\Omega$
3. Operation force	1.5~5kgf
4. Pull force of terminal	60N
5. Solderability test	$230 \pm 5^\circ\text{C} / 3\text{S}$
6. Soldering heat resistance	$260 \pm 5^\circ\text{C} / 5\text{S}$
7. Life test	6,000 cycle
8. Heat resistance	$80 \pm 2^\circ\text{C} / 96\text{h}$
9. Cold resistance	$-20 \pm 2^\circ\text{C} / 96\text{h}$
10. Salt spray test	24h

DRAWING

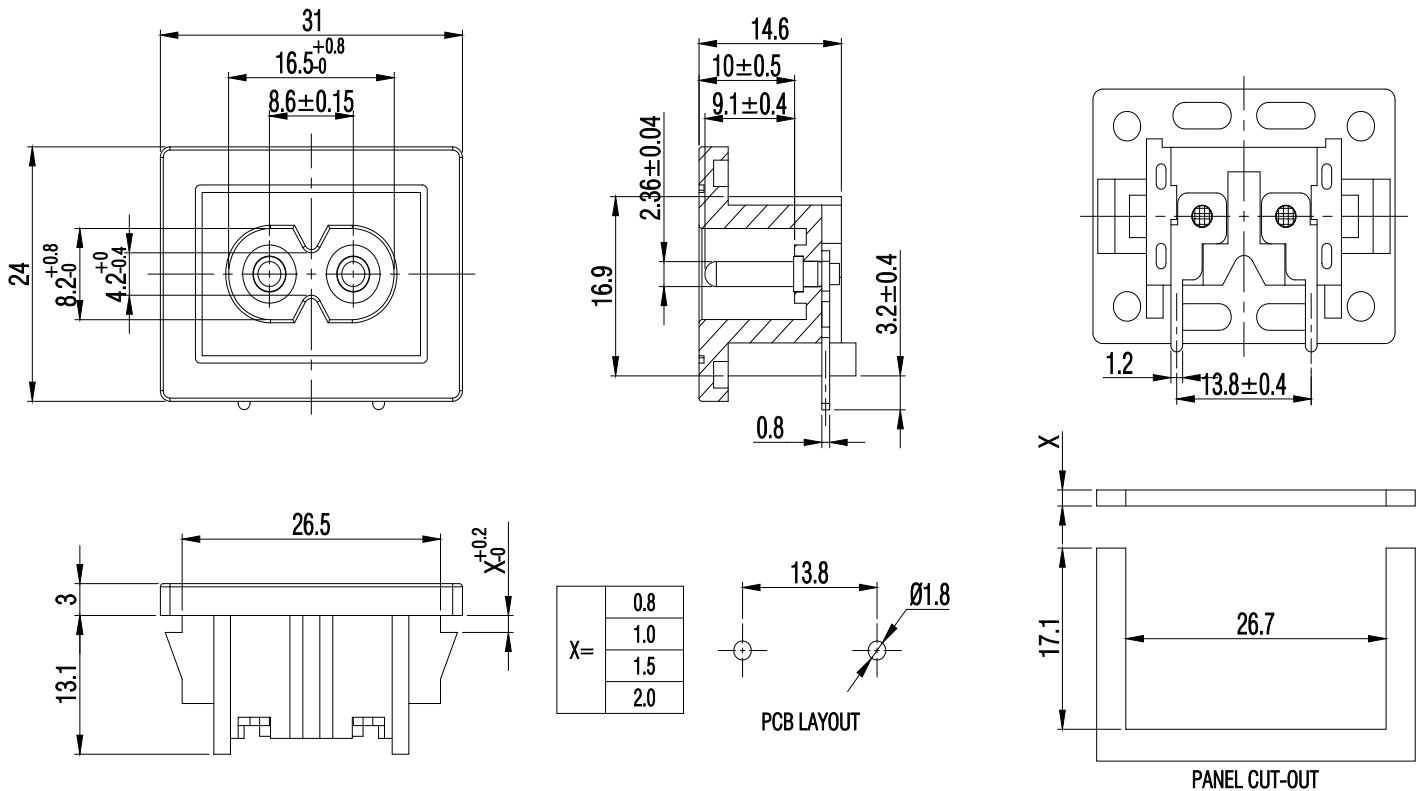

Terminals Type

