



衍惠电子

AC SOCKET



DB-14-S-2-P14P6 2.5A/250Vac & 5A/250Vac

SPECIFICATION



1. Dielectric withstand strength	AC 2000V/1min
2. Insulation resistance	≥ 100MΩ
3. Operation force	1.5~5kgf
4. Pull force of terminal	60N
5. Solderability test	230±5°C / 3S
6. Soldering heat resistance	260±5°C / 5S
7. Life test	6,000 cycle
8. Heat resistance	80±2°C / 96h
9. Cold resistance	-20±2°C / 96h
10. Salt spray test	24h

DRAWING

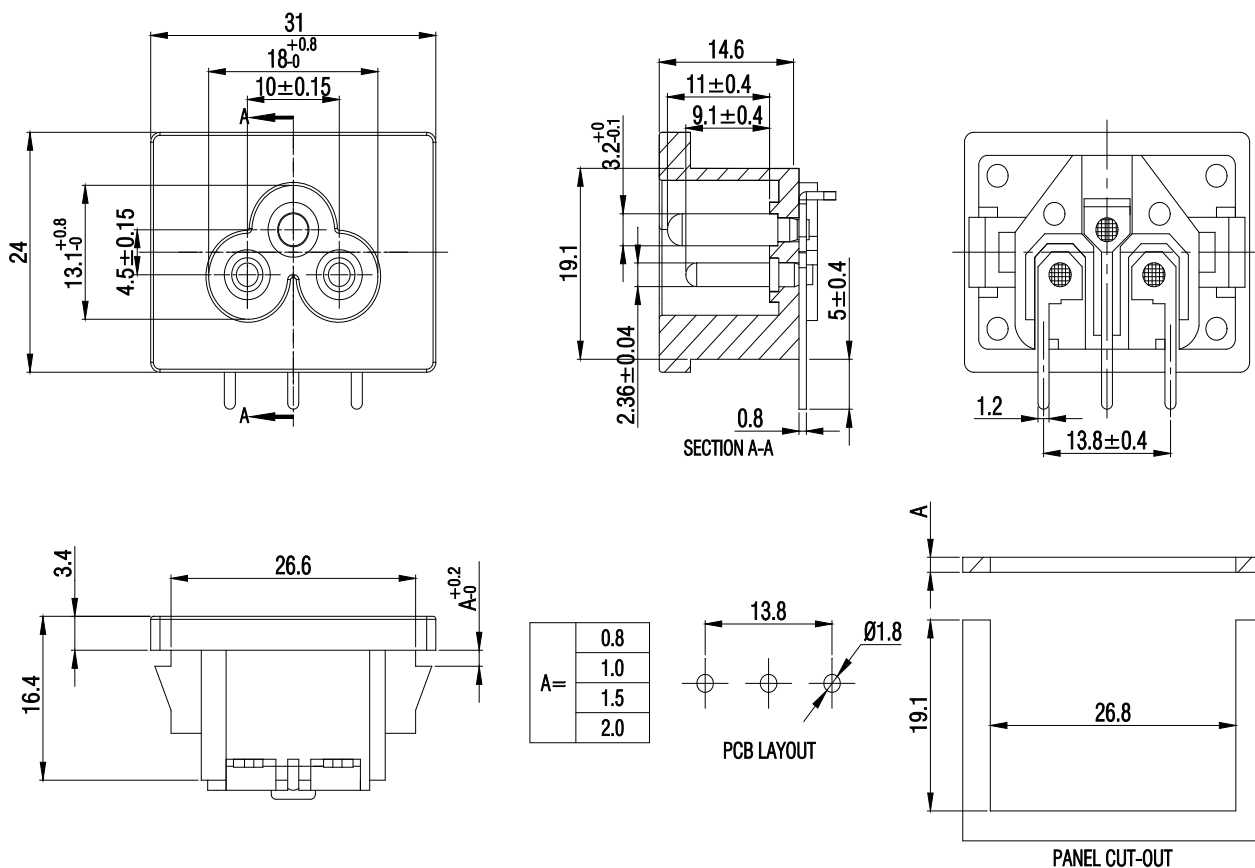

Terminals Type

Middle Terminal	P4	P5	P14	P19	P15	P16	S1	S1B	S2	P18	S3
Side Terminal	P3	P6	P7	P8	P9	P17	S1	P12			